

LIGHTWAY SOLAR MODULE

P 1640×990 Series for USA

(Available In Q4)



16.01%
Max. Efficiency

260W
Max Peak Power

10 YEAR
Product Warranty

25 YEAR
Linear Power Warranty



Positive Tolerance 0-5W
Provides our customers with maximum power output



Electric Current Classification
System output maximized by reducing mismatch losses up to 2% with modules sorted and package by amperage



Excellent weak light performance
Relative change of module efficiency at 200W/m² is less than 4%



Upto 5400Pa Mechanical load
Module certified to withstand extreme wind and snow loads



Passed Ammonia Gas and Salt Mist Corrosion Resistance Test
Tested and approved by TUV Rheinland according to IEC 62716 Draft C and FprEN 61701 Ed.2



ISO 9001:2008 - ISO 14001:2004 - OHSAS 18001:2007

PERFORMANCE AT LOW IRRADIANCE

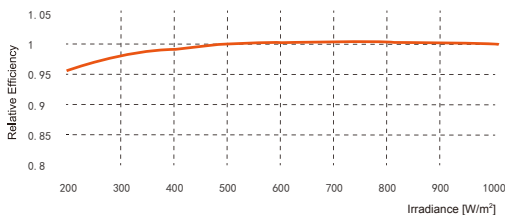

The typical relative change in module efficiency at an irradiance of 200W/m² in relation to 1000W/m² (both at 25°C and AM 1.5 spectrum) is less than 4%.

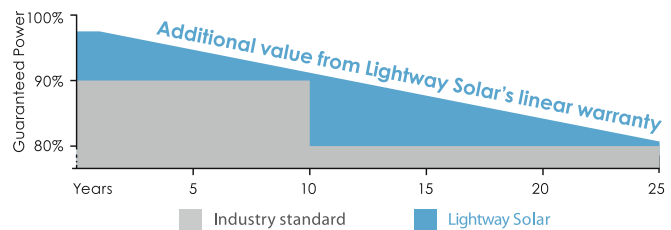

LINEAR WARRANTY

- 10-year warranty on materials and workmanship
- 25-year warranty > 80% power output
- 3% degradation rate the first year
- 0.68% yearly linear degradation



UL
• Qualified IEC 61713
• Safety tested
• IEC 61713
• Periodic inspection



ELECTRICAL DATA @ STC

Module Type		LW260(29) P1640×990	LW255(29) P1640×990	LW250(29) P1640×990	LW245(29) P1640×990	LW240(29) P 1640×990	LW235(29) P1640×990
Peak Power_Pmax	W	260	255	250	245	240	235
Power tolerance_ΔPmax	W	0,+5					
Voltage at Pmax_Vmpp	V	30.25	30.10	29.95	29.80	29.65	29.50
Current at Pmax_Imp	A	8.61	8.48	8.36	8.24	8.11	7.98
Open Circuit Voltage_Voc	V	37.95	37.88	37.80	37.50	37.40	37.30
Short Circuit Current_Isc	A	9.06	8.90	8.78	8.69	8.56	8.45
Module Efficiency_η		16.01%	15.71%	15.40%	15.09%	14.78%	14.47%

Values at standard test condition STC: air mass AM 1.5, irradiance 1000W/m², cells temperature 25 C

ELECTRICAL DATA @ NOCT

Module Type		LW260(29) P1640×990	LW255(29) P1640×990	LW250(29) P1640×990	LW245(29) P1640×990	LW240(29) P 1640×990	LW235(29) P1640×990
Peak Power_Pmax	W	192	188	185	180	176	173
Voltage at Pmax_Vmpp	V	28.46	28.42	28.28	27.94	27.77	27.59
Current at Pmax_Imp	A	6.73	6.63	6.53	6.45	6.35	6.26
Open Circuit Voltage_Voc	V	35.09	35.04	34.93	34.61	34.50	34.39
Short Circuit Current_Isc	A	7.34	7.21	7.12	7.04	6.94	6.85

Nominal operating cell temperature NOCT: irradiance 800W/m², ambient temperature 20 C, wind speed 1m/s

TEMPERATURE RATING

Nominal operating cell temperature(NOCT)	C	45±2
Temperature Coefficient of Pmax	%/C	-0.4204
Temperature Coefficient of Isc	%/C	0.0654
Temperature Coefficient of Voc	%/C	-0.3215

MAXIMUM RATING

Max. System Voltage	1000Vdc
Operating Temperature	-40 ~ +85 C
Max. Series Fuse Rating	15A
Max. Reverse Current	15A
Max. Mechanical load	5400Pa

CONSTRUCTION MATERIALS

Solar cells	60 mc , 156mm*156mm(cells original from Taiwan)
Glass	3.2mm low-iron tempered glass
Encapsulant	ethylene vinyl acetate(EVA)
Frame	anodized aluminium alloy(Silver)
Junction Box	≥IP65 rated, 3/6 diodes
Cable	4mm ² PV cable, 900mm/1200mm
Connector	MC4 compatible

GENERAL DATA

Module Dimension(L×W×H)	1640×990×40mm	1640×990×50mm
Weight	18.5kg	19.5kg

PACKING

Modules per pallet	26	20
Pallets per 40' container	28	28
Packing box dimension(L×W×H)	1700×1150×1040mm	1700×1150×1040mm

Unit:mm

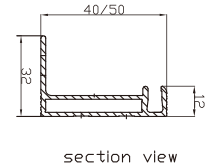
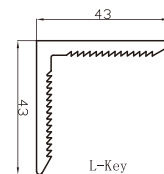
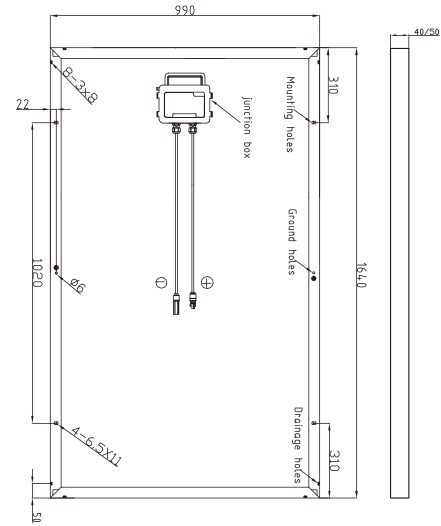

L-Key

section view

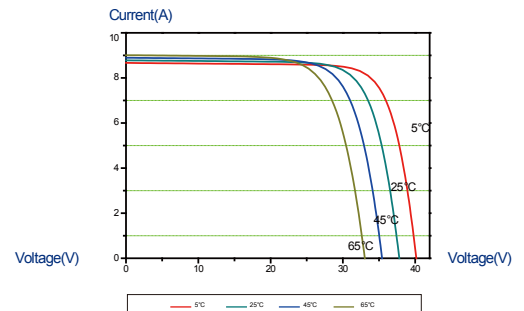
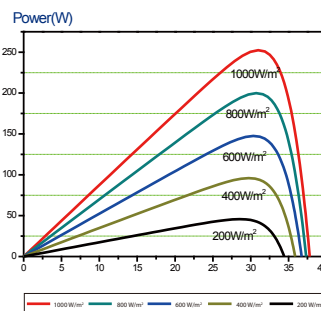
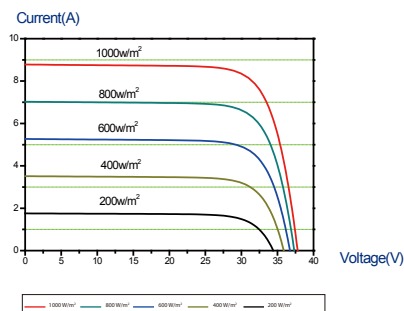

MKT-20130812